



ALLWEILER

*Peristaltic
Pumps*

The reliable pump people

Peristaltic Hose Pump

Principle of Operation

ALLWEILER peristaltic hose pumps use two sliding shoes or rollers to alternately compress a reinforced precision hose. The rotating shoes enclose a section of fluid in the hose and push it from the suction to the discharge end of the pump.

The enclosed section of the hose seals any liquid, vapor, or solids present in fluid and discharges them at up to 210 psi. No valves are required to prevent backflow.

The fluid is completely contained within the hose. No seals are ever required.

When released from the shoe, the hose returns to its original circular shape creating a vacuum. This vacuum is capable of operating at up to 31 feet of suction lift.

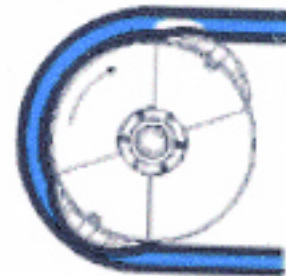
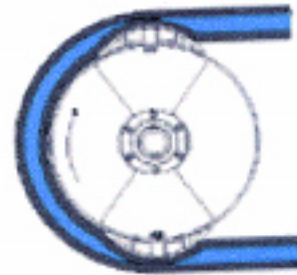
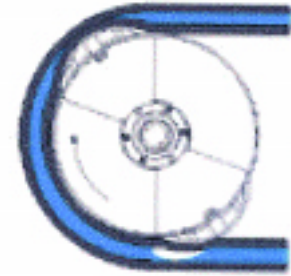

ALLWEILER Hose Pumps Provide:

- **Run Dry Protection**
Glycerin lubricates the shoe and dissipates excess heat, maximizing hose life and allowing the pump to run dry indefinitely.
- **Seal-Free Design**
Hose pumps require no shaft seals or internal valves because the fluid is completely contained in the hose. There is no metal-to-metal contact that can wear or leak.
- **Vapor Lock Prevention**
High suction lift and no valves prevent the pumps from experiencing vapor lock.
- **Dry Prime, High Suction Lift**
A reinforced hose and lack of valves allow ALLWEILER hose pumps to operate with up to 31 feet of suction lift.
- **Solids Handling**
Abrasive slurries or shear sensitive fluids precisely metered with +/- 1% flow accuracy with no flow abrasive wear.

Typical Applications

High Viscosity

- Glues or Resin
- Inks or Varnish
- Detergents or Toothpaste

High Solids Content

- Sludge or Scum
- Clay or Lime Slurry
- Cement or Mortar

Shear Sensitive

- Polymer
- Latex
- Pharmaceuticals or Cosmetics

Other Tough Application

- Mine Tailings
- Radioactive Waste
- Pulp



ASL and ASH Series

ASL: Low Pressure

- Pressure up to 60 PSI
- Temperature up to 122 °F
- Viscosity up to 40,000 cPS

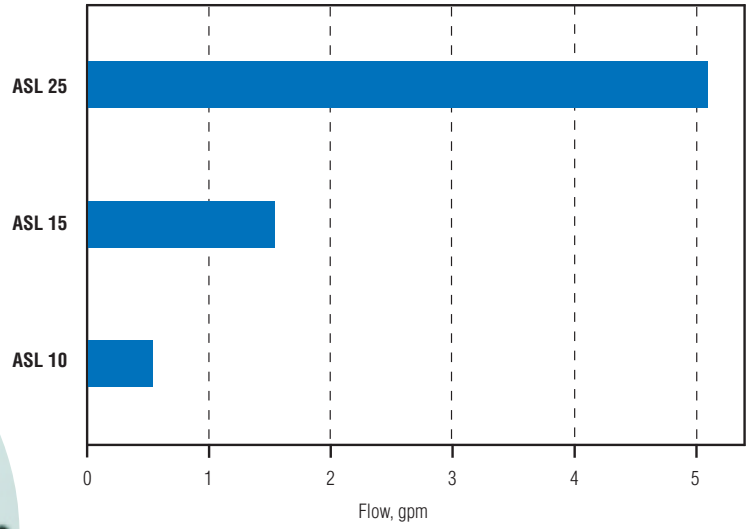
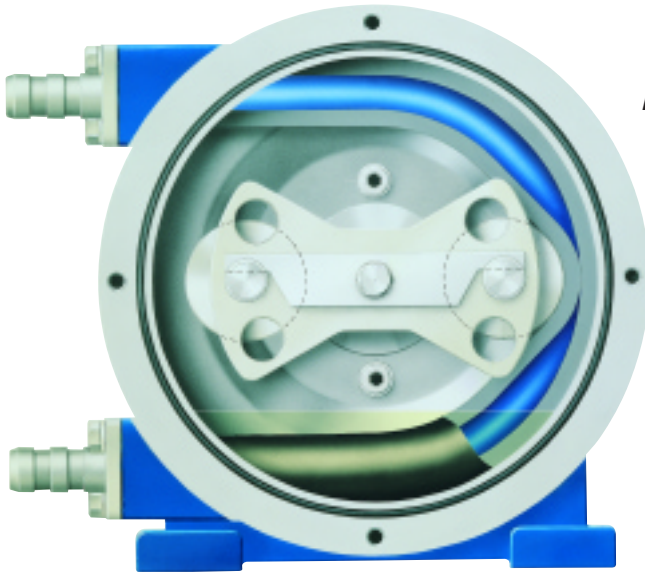

ASH: High Pressure

- Pressure up to 220 PSI
- Temperature up to 175 °F
- Viscosity up to 100,000 cPS

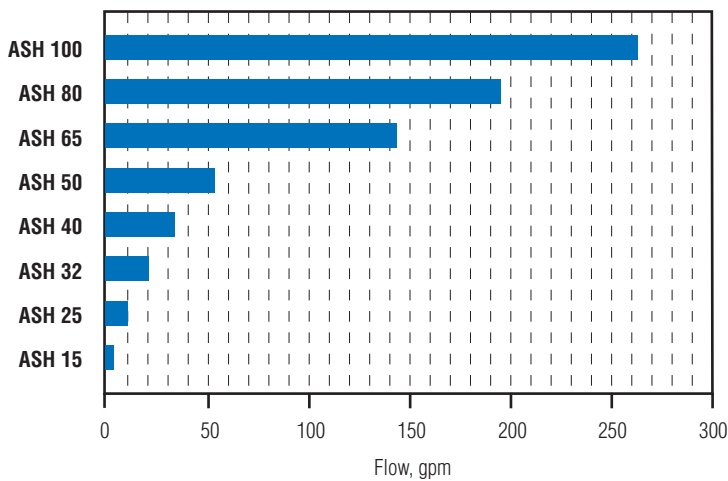

ASH High Pressure Hose Pump

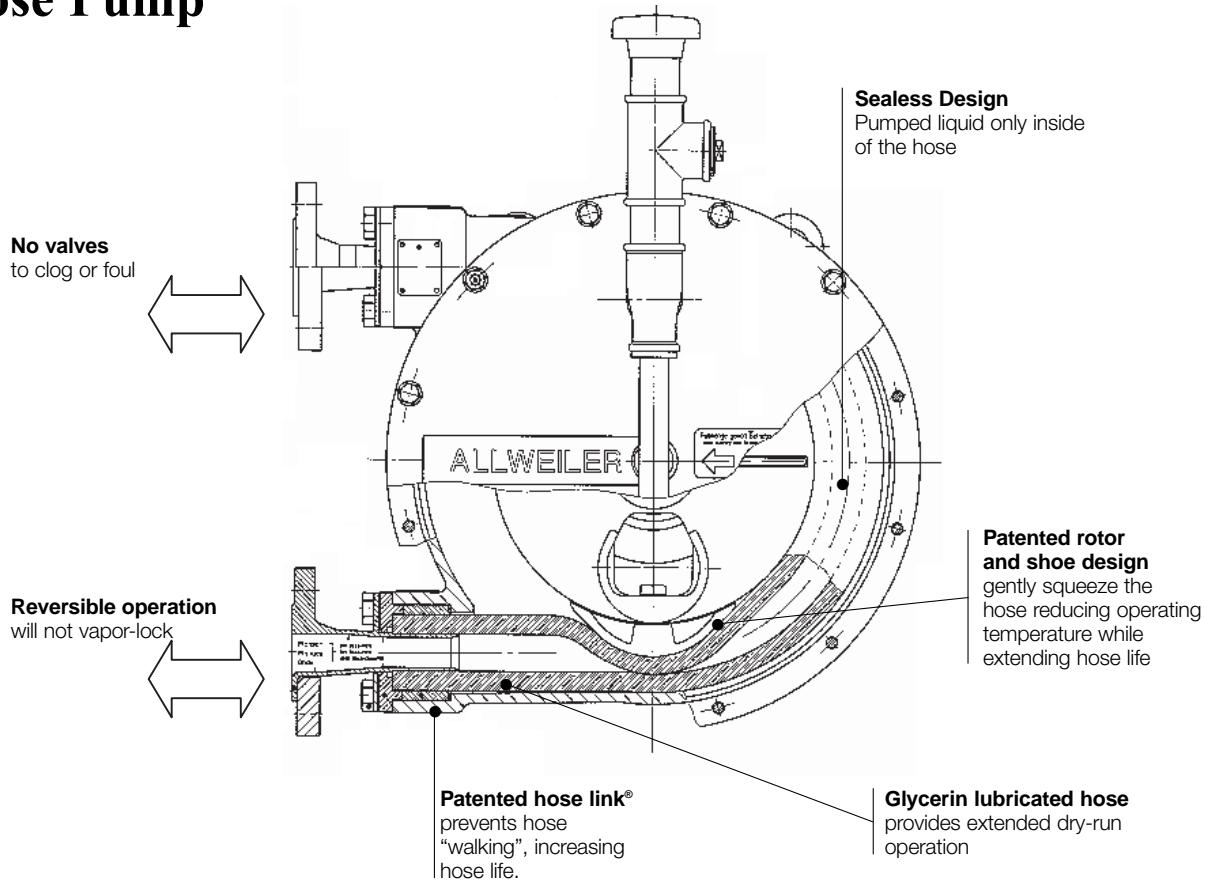

ASH 40 A 4 - NR

- ① ② ③ ④ ⑤

Type Coding								
Position	Designation	Explanation						
①	Series	ASH- High Pressure Hose Pump Pump Casing: Cast Iron Rotor: Ductile Cast Iron Sliding Shoe: Aluminum Alloy						
②	Size	15, 25, 32, 40, 50, 65, 80, 100 The number indicates the hose diameter in mm						
③	Type of Connection	A: ANSI class 150, 316 stainless steel weld neck flange L: ANSI class 150, lap joint flange 316 stainless steel with plastic wetted parts						
④	Connection Location	See pump dimension drawing for positions 1, 2, 3, or 4 location						
⑤	Hose Material	The multi-ply hose uses natural rubber on the outer layers to provide excellent mechanical properties, resist wear, and maximizes hose life. The inner layer of the hose must be compatible with the pumped liquid. Available materials include: <table border="1" style="width: 100%; border-collapse: collapse;"> <tr> <td style="width: 30%;">NR- Natural Rubber</td> <td>175 °F to -5 °F, Always the preferred choice. Resilient material with excellent abrasion resistance and mechanical properties. Generally resistant to alcohols, dilute acids and caustics (pH 5-14).</td> </tr> <tr> <td>NBR- Perbunan (Nitrate)</td> <td>175 °F to 20 °F, Highly abrasion resistant. Generally resistant to fats, oils, caustics and detergents.</td> </tr> <tr> <td>CSM- Hypalon,</td> <td>175 °F to 20 °F, Generally resistant to concentrated acids, ketones and alcohols. Consult the factory applications engineers for specific properties and compatibility.</td> </tr> </table>	NR- Natural Rubber	175 °F to -5 °F, Always the preferred choice. Resilient material with excellent abrasion resistance and mechanical properties. Generally resistant to alcohols, dilute acids and caustics (pH 5-14).	NBR- Perbunan (Nitrate)	175 °F to 20 °F, Highly abrasion resistant. Generally resistant to fats, oils, caustics and detergents.	CSM- Hypalon,	175 °F to 20 °F, Generally resistant to concentrated acids, ketones and alcohols. Consult the factory applications engineers for specific properties and compatibility.
NR- Natural Rubber	175 °F to -5 °F, Always the preferred choice. Resilient material with excellent abrasion resistance and mechanical properties. Generally resistant to alcohols, dilute acids and caustics (pH 5-14).							
NBR- Perbunan (Nitrate)	175 °F to 20 °F, Highly abrasion resistant. Generally resistant to fats, oils, caustics and detergents.							
CSM- Hypalon,	175 °F to 20 °F, Generally resistant to concentrated acids, ketones and alcohols. Consult the factory applications engineers for specific properties and compatibility.							

ASH Pump and Gear Motor Dimensions

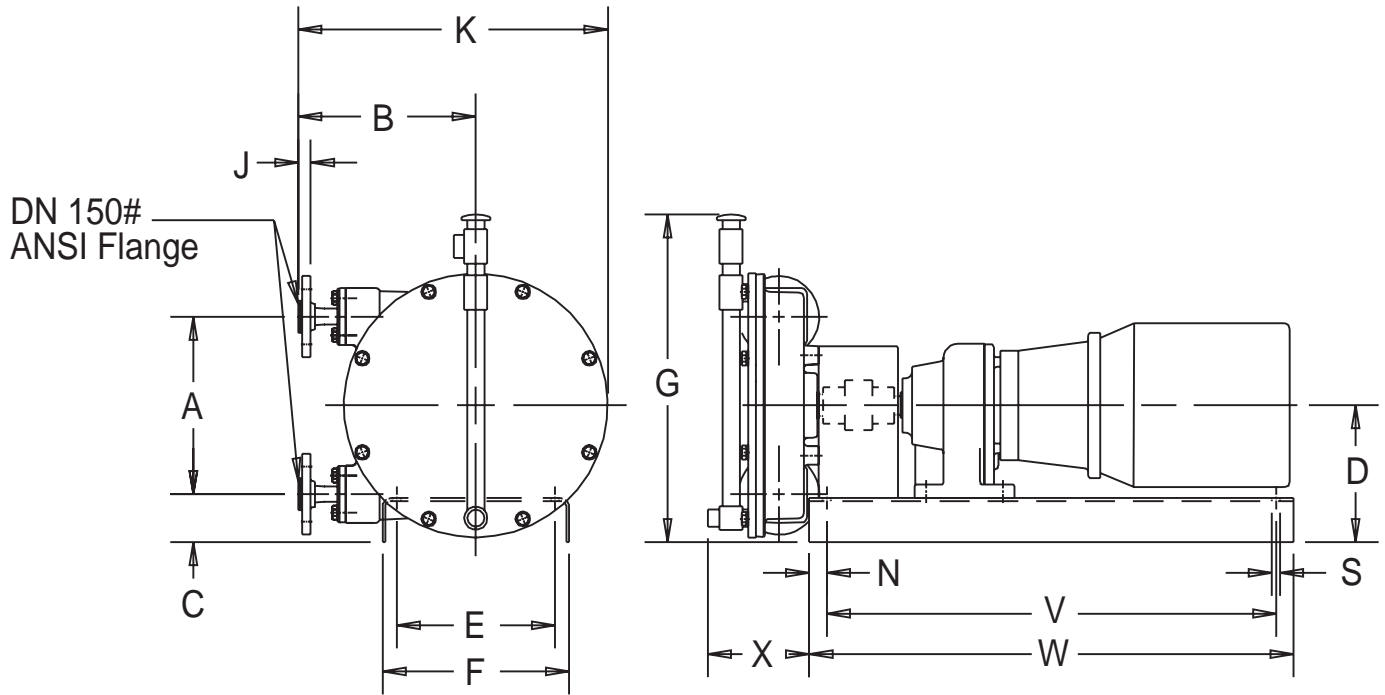

PUMP	A	B	C	D	E	F	G	J
ASH 15	7.7	7.7	2.35	6.2	12.0	15.0	11.9	0.67
ASH 25	10.4	9.8	2.60	7.8	15.5	18.5	20.4	0.83
ASH 32	13.0	11.7	3.10	9.6	18.0	21.0	23.4	0.91
ASH 40	16.9	13.4	3.35	11.8	20.5	23.5	27.7	0.94
ASH 50	21.8	16.3	3.80	14.7	26.5	28.5	36.0	1.06
ASH 65	29.4	20.0	4.30	19.0	32.5	34.5	44.0	1.18
ASH 80	34.5	24.2	4.95	22.2	36.0	39.0	49.9	1.30
ASH 100	41.0	28.3	5.60	26.1	42.0	45.0	96.7	1.42

Dimensions in inches.

PUMP	K	N	S	V	W	X	DN	COUPLING
ASH 15	13.4	1.5	0.75	20.75	23.75	4.7	0.50	LS100
ASH 25	17.1	1.5	0.75	28.00	31.00	7.9	1.25	LS195
ASH 32	20.7	1.5	0.75	28.00	31.00	7.9	1.25	LS195
ASH 40	24.7	1.5	0.75	32.00	35.00	8.5	1.50	LS2252
ASH 50	30.5	1.5	0.75	37.50	40.50	10.7	2.00	CS280
ASH 65	38.5	1.5	0.75	42.50	45.50	11.9	2.50	H3267
ASH 80	45.9	1.5	0.75	46.75	49.75	13.2	3.00	H3667
ASH 100	53.9	1.5	0.75	57.00	60.00	14.8	4.00	*SER 71

Dimensions in inches. *SER 71 is Thomas; All others are Lovejoy

ASL Low Pressure Hose Pump

Sealless Design

Pumped liquid only inside of the hose

No valves
to clog or foul

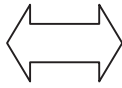

Reversible operation
will not vapor-lock

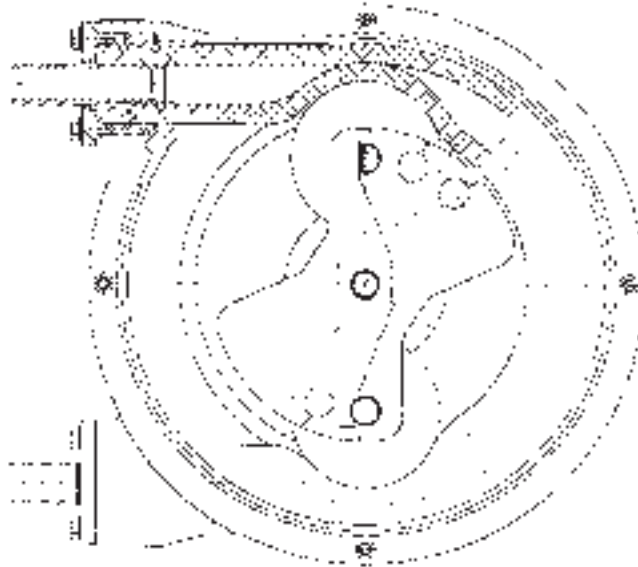
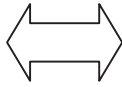

Patented rotor and shoe design

gently squeeze the hose reducing operating temperature while extending hose life

Patented hose link®

prevents hose "walking", increasing hose life.

Glycerin lubricated hose

provides extended dry-run operation

ASL 15 TS 4 L - NR

- ① ② ③ ④ ⑤ ⑥

Type Coding

Position	Designation	Explanation						
①	Series	ASL- Low Pressure Hose Pump Pump Casing: Alumimum Rotor: Ductile Cast Iron Sliding Shoe: Composite						
②	Size	10, 15, 25 The number indicates the diameter of the hose in mm						
③	Type of Connection	TS: Barbed tubing fitting in Stainless Steel (ASL only) TP: Barbed Tubing fitting in Polyethylene (ASL only)						
④	Connection Location	See pump dimension drawing for positions 1, 2, 3, or 4 location						
⑤	Hose Rating	L: Low pressure suitable for up to 20 PSI M: Medium pressure suitable for up to 40 PSI						
⑥	Hose Material	The multi-ply hose uses natural rubber on the outer layers to provide excellent mechanical properties, resist wear, and maximizes hose life. The inner layer of the hose must be compatible with the pumped liquid. Available materials include: <table border="1" style="width: 100%; border-collapse: collapse;"> <tr> <td style="width: 30%;">NR- Natural Rubber</td> <td>122 °F to -5 °F, Always the preferred choice. Resilient material with excellent abrasion resistance and mechanical properties. Generally resitant to alcohols, dilute acids and caustics (pH 5-14)).</td> </tr> <tr> <td>NBR- Perbunan (Nitrate)</td> <td>122 °F to 20 °F, Highly abrasion resistant. Generally resistant to fats, oils, caustics and detergents.</td> </tr> <tr> <td>CSM- Hypalon,</td> <td>122 °F to 20 °F, Generally resitant to concentrated acids, ketones and alcohols. Consult the factory applications engineers for specific properties and compatibility.</td> </tr> </table>	NR- Natural Rubber	122 °F to -5 °F, Always the preferred choice. Resilient material with excellent abrasion resistance and mechanical properties. Generally resitant to alcohols, dilute acids and caustics (pH 5-14)).	NBR- Perbunan (Nitrate)	122 °F to 20 °F, Highly abrasion resistant. Generally resistant to fats, oils, caustics and detergents.	CSM- Hypalon,	122 °F to 20 °F, Generally resitant to concentrated acids, ketones and alcohols. Consult the factory applications engineers for specific properties and compatibility.
NR- Natural Rubber	122 °F to -5 °F, Always the preferred choice. Resilient material with excellent abrasion resistance and mechanical properties. Generally resitant to alcohols, dilute acids and caustics (pH 5-14)).							
NBR- Perbunan (Nitrate)	122 °F to 20 °F, Highly abrasion resistant. Generally resistant to fats, oils, caustics and detergents.							
CSM- Hypalon,	122 °F to 20 °F, Generally resitant to concentrated acids, ketones and alcohols. Consult the factory applications engineers for specific properties and compatibility.							

ASL Pump and Gear Motor Dimensions

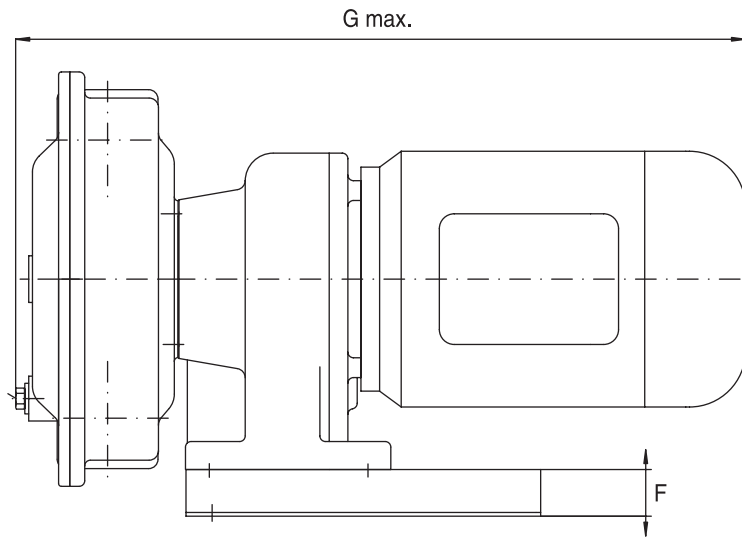
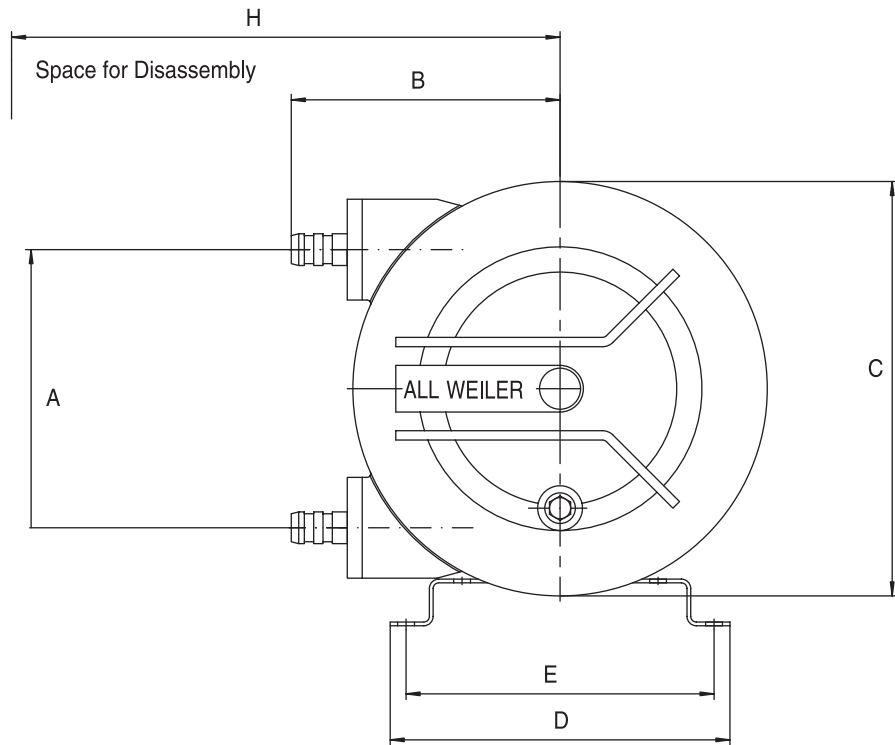

PUMP	A	B	C	D	E	F	G	H
ASL 10	4.3	4.4	6.5	7.2	6.5	1.0	14.9	9.1
ASL 15	5.9	5.7	8.7	7.2	6.5	1.0	16.2	14.6
ASL 25	10.4	9.4	14.6	13.0	11.8	3.5	20.6	20.9

Dimensions in inches.

ASL Low Pressure Hose Pump Performance Charts

ASL 10

Inner Hose Diameter 10 mm
 Connection 1/2" npt
 Capacity per rev. 0.0056 gal
 Starting Torque 4 lb-ft
 Max. Spherical Solid 0.131"
 Max. Temperature 104 °F

In chart shown
 Liquid: water
 Inlet Pressure: 0 PSID

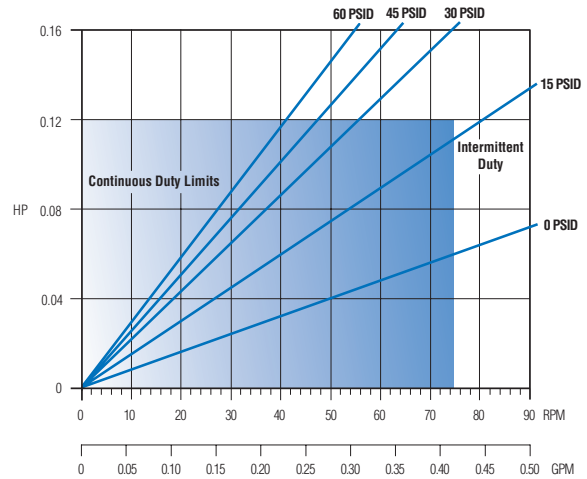

ASL 15

Inner Hose Diameter 15 mm
 Connection 1/2" npt
 Capacity per rev. 0.0172 gal
 Starting Torque 15 lb-ft
 Max. Spherical Solid 0.197"
 Max. Temperature 104 °F

In chart shown
 Liquid: water
 Inlet Pressure: 0 PSID

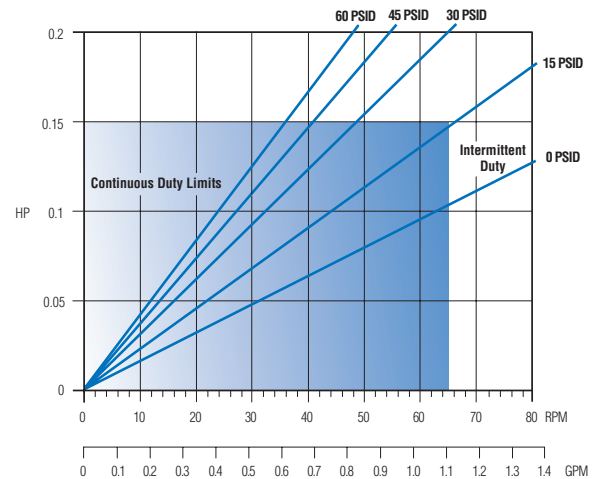

ASL 25

Inner Hose Diameter 25 mm
 Connection 1" npt
 Capacity per rev. 0.079 gal
 Starting Torque 30 lb-ft
 Max. Spherical Solid 0.328"
 Max. Temperature 104 °F

In chart shown
 Liquid: water
 Inlet Pressure: 0 PSID

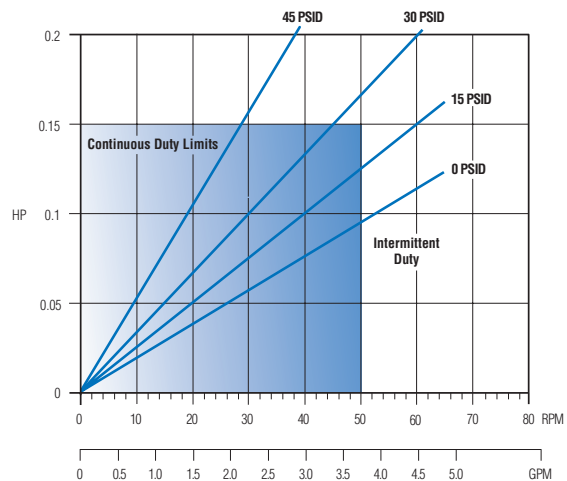

How to Calculate Speed/Horsepower

1. Flow required determines pump speed
2. Read calculated discharge pressure
3. Horsepower required

ASH High Pressure Hose Pump Performance Charts

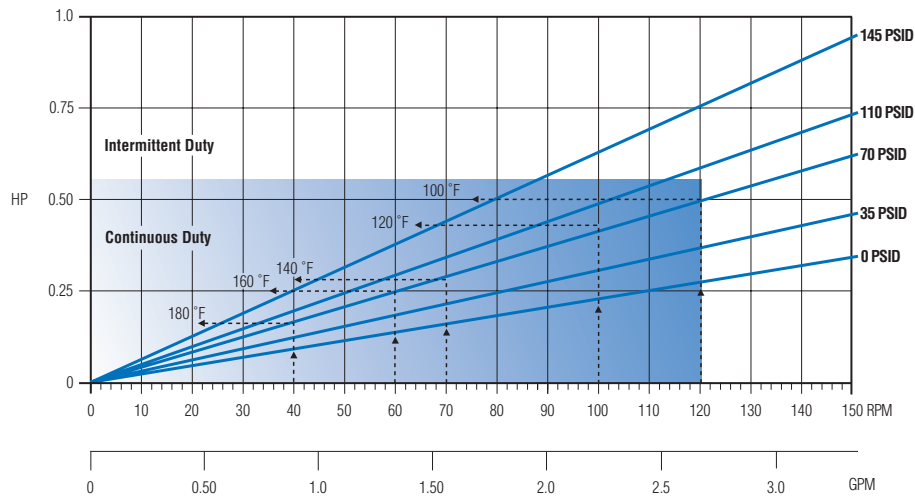

ASH 15

Inner Hose Diameter 15 mm
 Connection 1/2" - 150 FF
 Capacity per rev. 0.022 gal
 Starting Torque 80 lb-ft
 Max. Spherical Solid 0.19"
 Max. Temperature 122 °F

In chart shown
 Liquid: water
 Inlet Pressure: 0 PSI

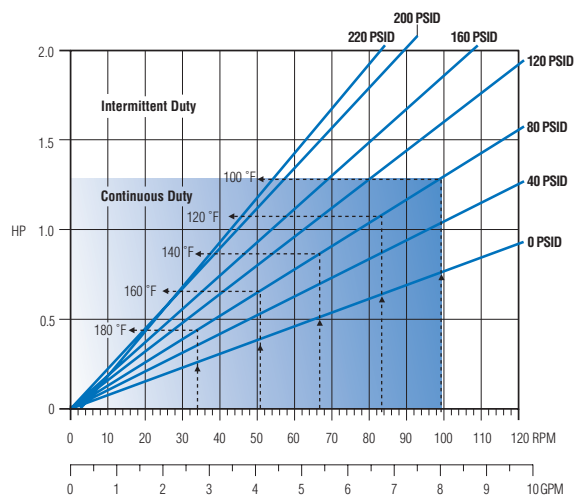

ASH 25

Inner Hose Diameter 25 mm
 Connection 1" - 150 FF
 Capacity per rev. 0.079 gal
 Starting Torque 133 lb-ft
 Max. Spherical Solid 0.33"
 Max. Temperature 122 °F

In chart shown
 Liquid: water
 Inlet Pressure: 0 PSI

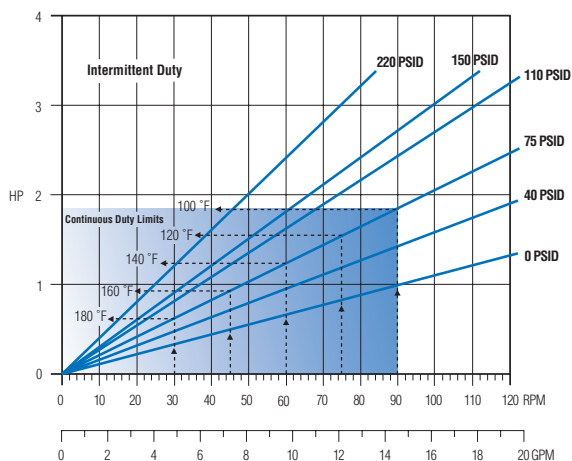

ASH 32

Inner Hose Diameter 32 mm
 Connection 1 1/4" - 150 FF
 Capacity per rev. 0.164 gal
 Starting Torque 162 lb-ft
 Max. Spherical Solid 0.42"
 Max. Temperature 122 °F

In chart shown
 Liquid: water
 Inlet Pressure: 0 PSI

How to Calculate Speed/Horsepower

1. Flow required determines pump speed
2. Read calculated discharge pressure
3. Horsepower required

ASH High Pressure Hose Pump Performance Charts

ASH 40

Inner Hose Diameter 40 mm
 Connection 1 1/2" - 150 FF
 Capacity per rev. 0.351 gal
 Starting Torque 376 lb-ft
 Max. Spherical Solid .52"
 Max. Temperature 122 °F

In chart shown
 Liquid: water
 Inlet Pressure: 0 PSI

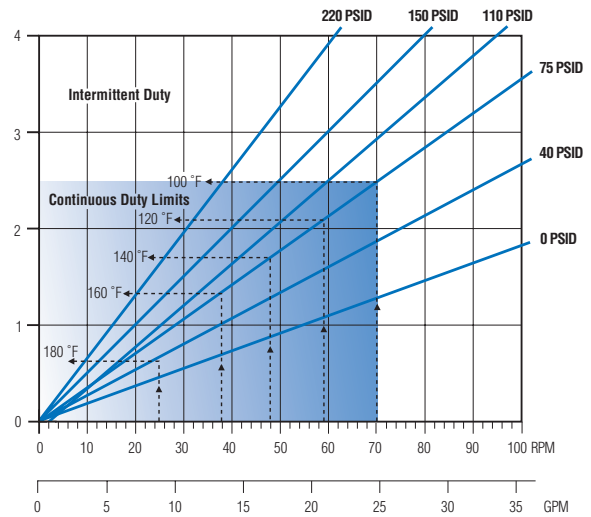

ASH 50

Inner Hose Diameter 50 mm
 Connection 2" - 150 FF
 Capacity per rev. 0.767 gal
 Starting Torque 885 lb-ft
 Max. Spherical Solid 0.65"
 Max. Temperature 122 °F

In chart shown
 Liquid: water
 Inlet Pressure: 0 PSI

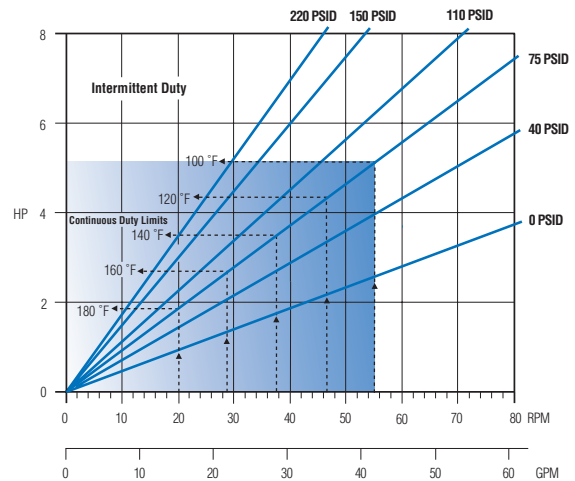

ASH 65

Inner Hose Diameter 65 mm
 Connection 2 1/2" - 150 FF
 Capacity per rev. 0.35 gal
 Starting Torque 1625 lb-ft
 Max. Spherical Solid 0.52"
 Max. Temperature 122 °F

In chart shown
 Liquid: water
 Inlet Pressure: 0 PSI

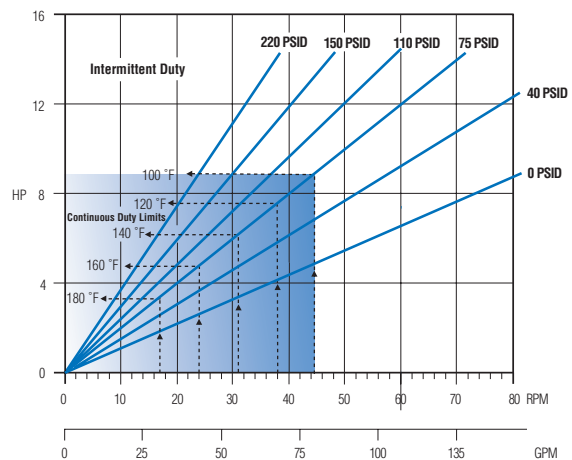

How to Calculate Speed/Horsepower

1. Flow required determines pump speed
2. Read calculated discharge pressure
3. Horsepower required

ASH High Pressure Hose Pump Performance Charts

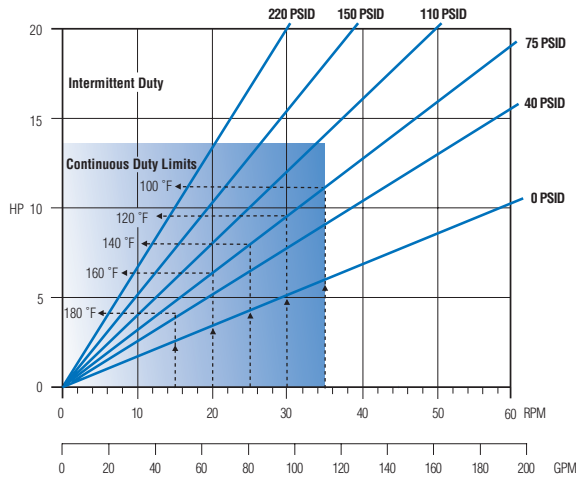

ASH 80

Inner Hose Diameter 80 mm
 Connection 3" - 150 FF
 Capacity per rev. 3.08 gal
 Starting Torque 2213 lb-ft
 Max. Spherical Solid 1.05"
 Max. Temperature 122 °F

In chart shown
 Liquid: water
 Inlet Pressure: 0 PSI

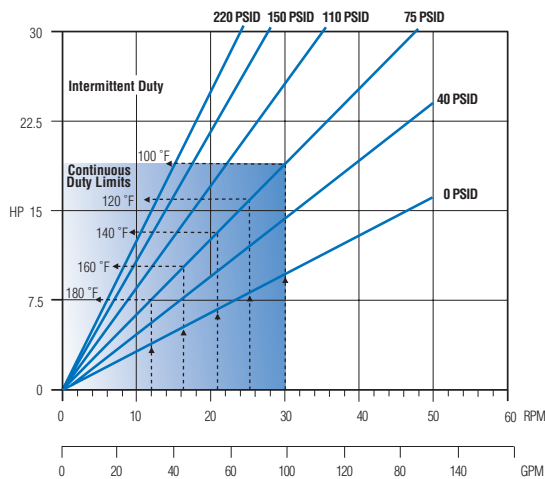

ASH 100

Inner Hose Diameter 100 mm
 Connection 4" - 150 FF
 Capacity per rev. 5.28 gal
 Starting Torque 2950 lb-ft
 Max. Spherical Solid 1.31"
 Max. Temperature 122 °F

In chart shown
 Liquid: water
 Inlet Pressure: 0 PSI

How to Calculate Speed/Horsepower

1. Flow required determines pump speed
2. Read calculated discharge pressure
3. Horsepower required

Allweiler is proud to be a member of the Colfax Pump Group associated with Imo Pump, Monroe, North Carolina, USA; Warren Pump, Warren, Massachusetts, USA; and Houttuin Pump, Utrecht, The Netherlands, providing world-class fluid handling equipment and services to a global market.

Allweiler in a word means, "performance." Allweiler Peristaltic Pump's "performance over time" provides the best overall value by providing low maintenance or lengthy, reliable service intervals and efficient product operation or low energy costs, which results in the lowest "total cost of ownership".

Every Allweiler Peristaltic Pump product is designed to be Of "heavy duty – industrial grade" construction and certain models are designed specifically for "severe duty" services such as marine, power generation or process applications.

Allweiler Peristaltic Pumps are fully qualified to respond on all of the imposed quality and design standards provided, such as ABS, ANSI, ASME, DIN, ISO-9000, CE, UL, CSA, NEMA and ISO, among others.

Allweiler maintains in the USA a fully qualified staff of experienced application engineers, technical sales engineers, product engineers, service engineers and draftsmen capable of handling the most demanding applications.

We respond to our customer needs with efficient, reliable products capable of handling a wide range of fluids over a long service life.

Our QuickServe Department processes Internet and credit card orders. Most repair parts can be shipped same or next business day from North Carolina, saving valuable down time. Visit Our E-Commerce site on the web or call our Customer service department to place your...Order today!

www.progressingcavity.com



Quality Management System



Brand

A Member of the COLFAX PUMP GROUP

IMO Pump

1710 Airport Road 28110
 PO Box 5020
 Monroe, NC 28111-5020 USA
 Tel: 1+ (704) 289.6511
 Fax: 1+ (704) 289.9273
 Email: imo.pump@colfaxcorp.com
 Web: www.progressingcavity.com



ALLWEILER



HOUTTUIN



IMO PUMP



WARREN



The reliable pump people

©2002 Imo Pump All rights reserved.